

9 8 7 6 5 4 3 2 1

G
F
E
D
C
B
A

G
F
E
D
C
B
A

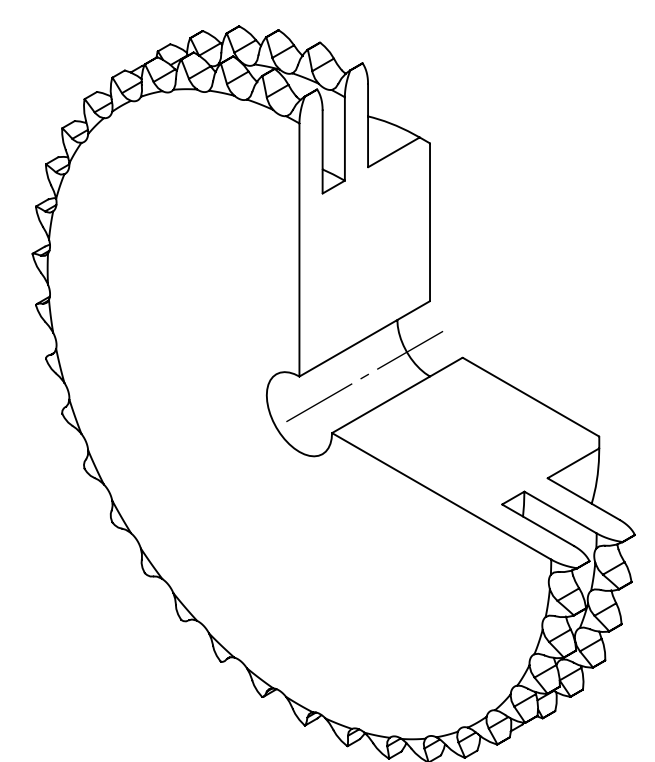
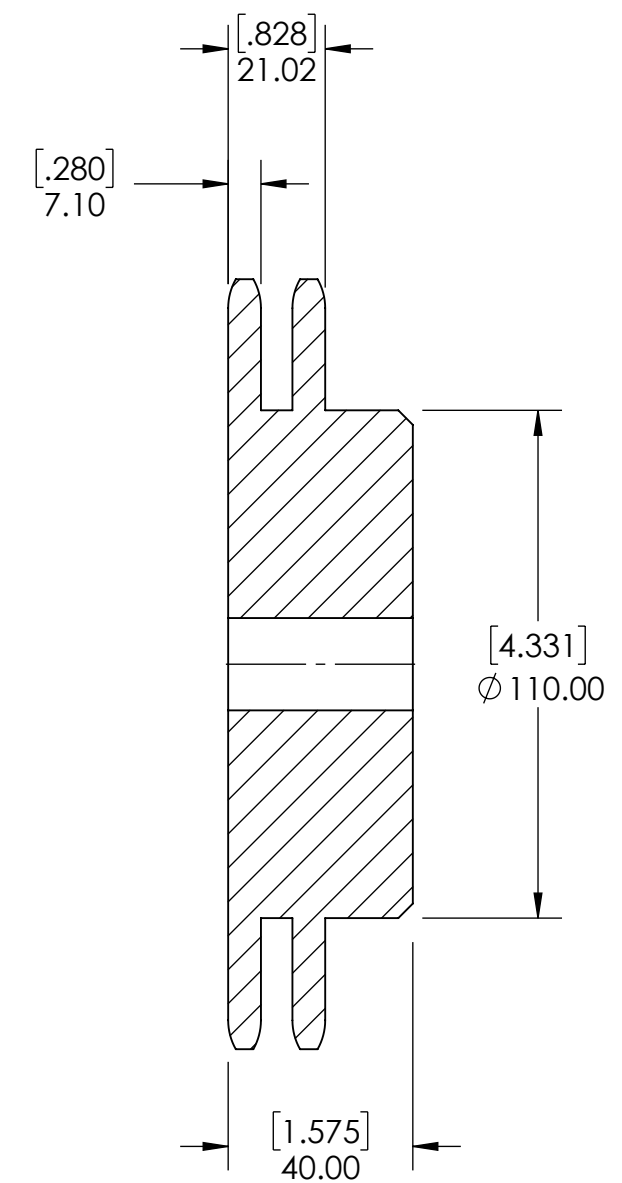
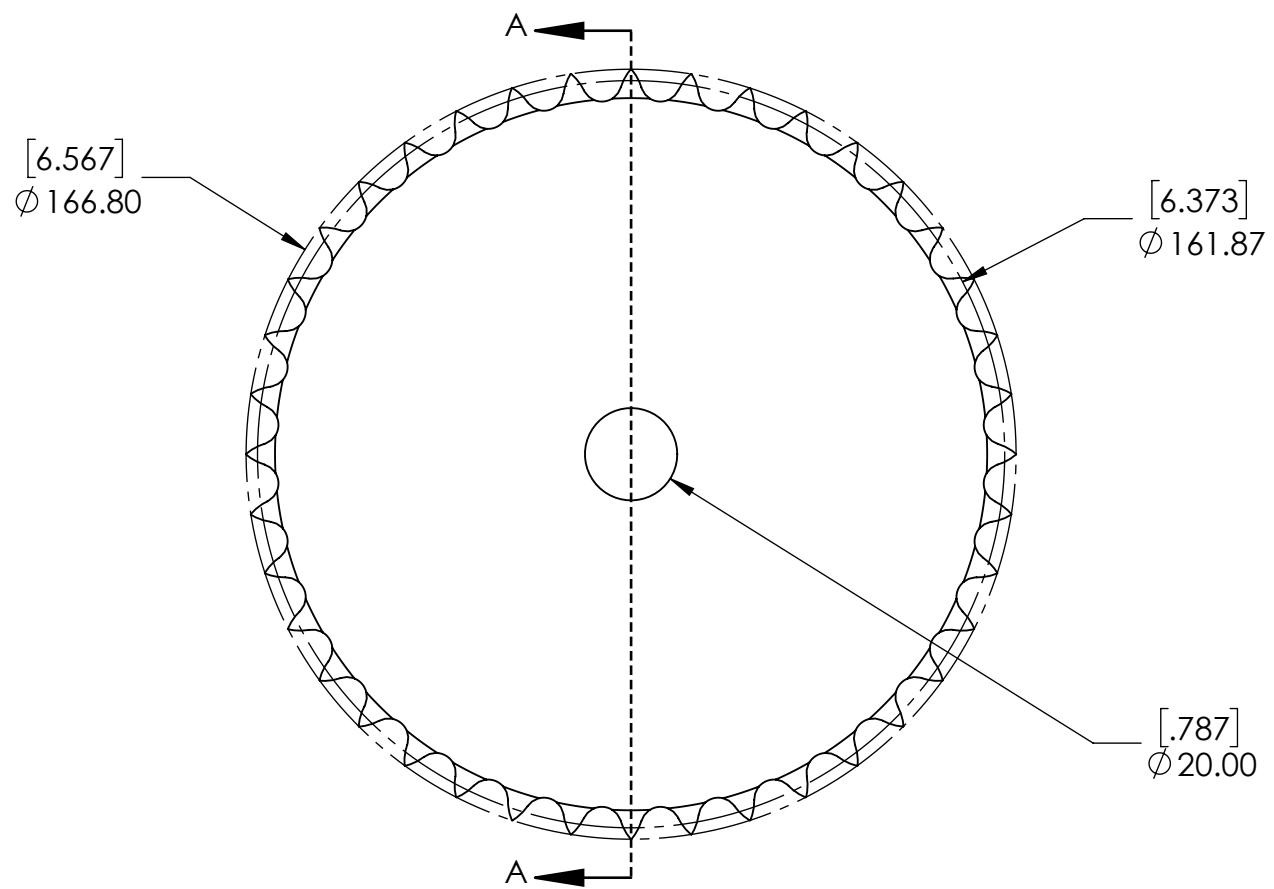

SECTION A-A

SPROCKETS SPECIFICATIONS		WEIGHT		DATE		BY		REVISION DESCRIPTION		REV
UNITS	mm (INCH)	8.79 LBS								
CHAIN SIZE	08B	STEEL								
PITCH	12.70 mm	BLACK OXIDE		07/30/2025						
INNER WIDTH	7.75 mm	DRAWN		SEC						
ROLLER DIA.	8.51 mm	CHECKED		PT		08/06/2025				
TOOTH WIDTH	7.10 mm	APPROVED								
NUMBER OF TEETH	40	THIRD ANGLE PROJECTION								
HUB STYLE	B	DWG. NO.								
BORE TYPE	PLAIN BORE	PTI		PROPRIETARY AND CONFIDENTIAL						
BUSHING NUMBER	N/A	ITEM DESCRIPTION:		08B-2-40B						
										SCALE
										1:1
										REV
										-

9 8 7 6 5 4 3 2 1