

9 8 7 6 5 4 3 2 1

G
F
E
D
C
B
A

G
F
E
D
C
B
A

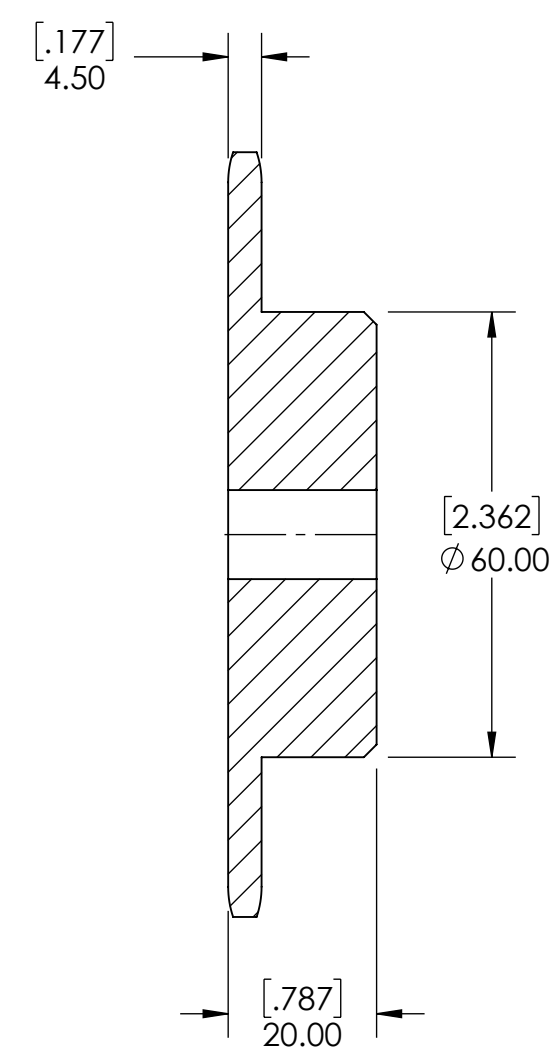
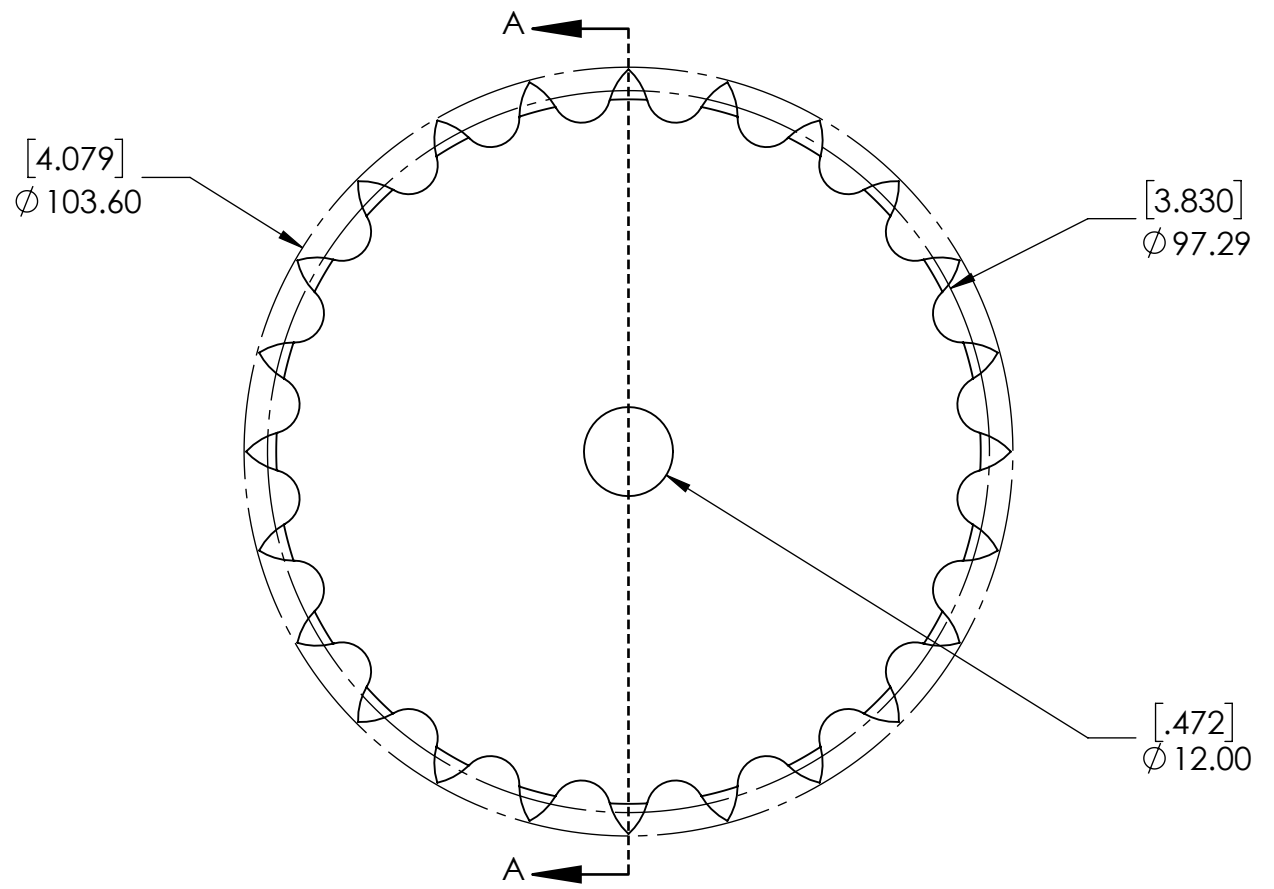

SECTION A-A

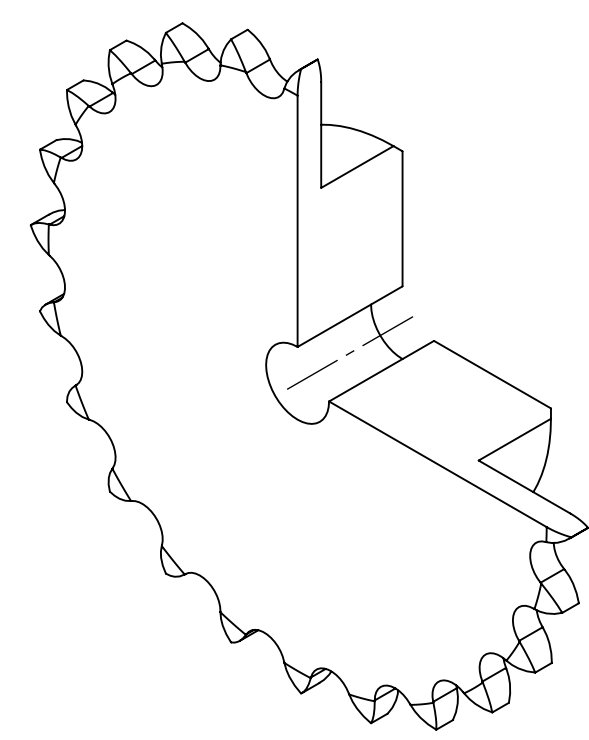

SPROCKETS SPECIFICATIONS		WEIGHT		DATE		BY		REVISION DESCRIPTION		REV
UNITS	mm (INCH)	1.26 LBS								
CHAIN SIZE	083B	MATERIAL	STEEL							
PITCH	12.70 mm	COATING	BLACK OXIDE							
INNER WIDTH	4.88 mm	DRAWN	SEC	08/18/2025						
ROLLER DIA.	7.75 mm	CHECKED	DH	08/18/2025						
TOOTH WIDTH	4.50 mm	APPROVED								
NUMBER OF TEETH	24									
HUB STYLE	B									
BORE TYPE	PLAIN BORE									
BUSHING NUMBER	N/A									
		DWG. NO.								
						ITEM DESCRIPTION:				SCALE
						083B-24B				1:1
										REV
										-

9 8 7 6 5 4 3 2 1