

9 8 7 6 5 4 3 2 1

G
F
E
D
C
B
A

G
F
E
D
C
B
A

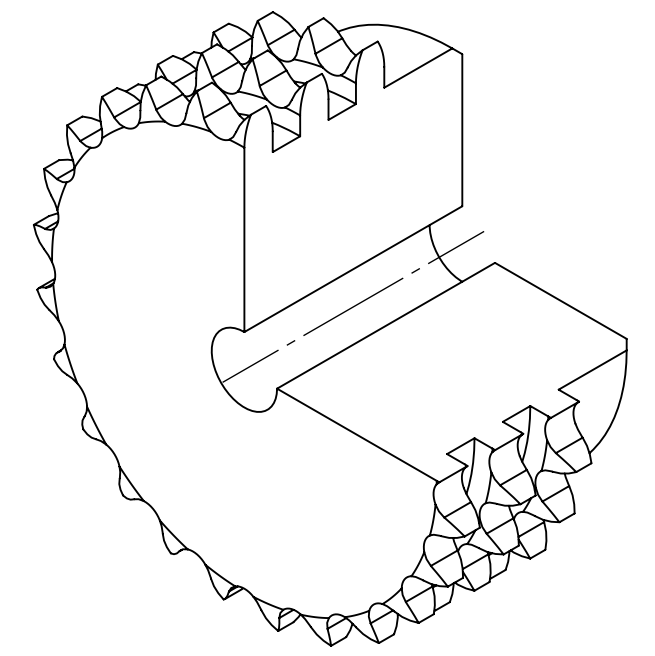
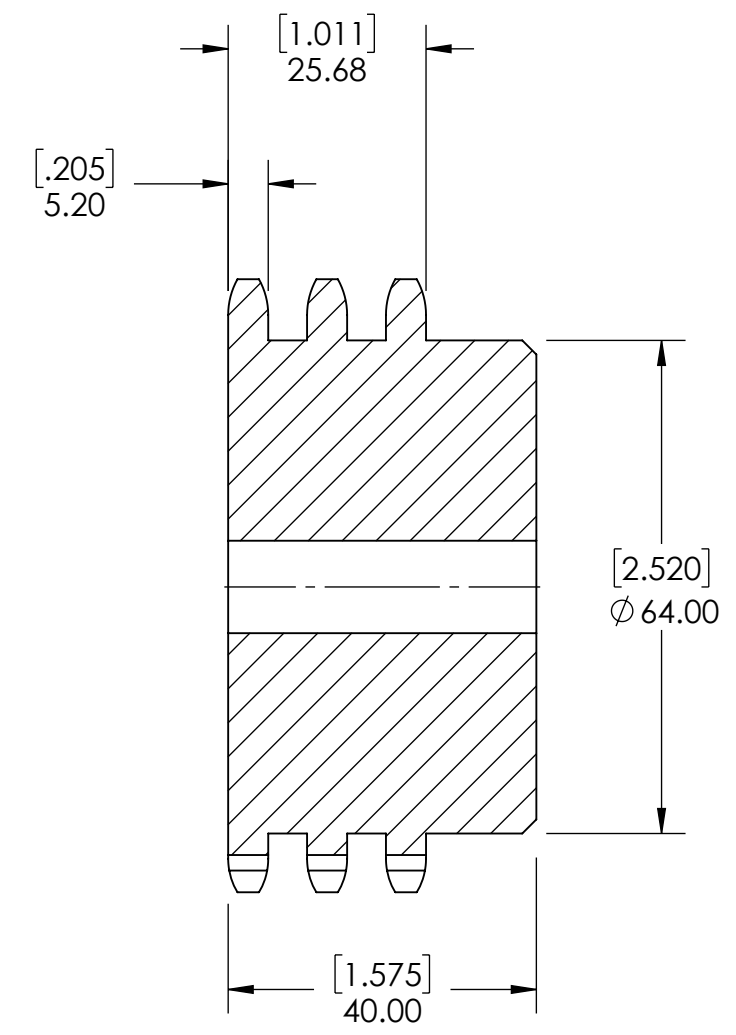
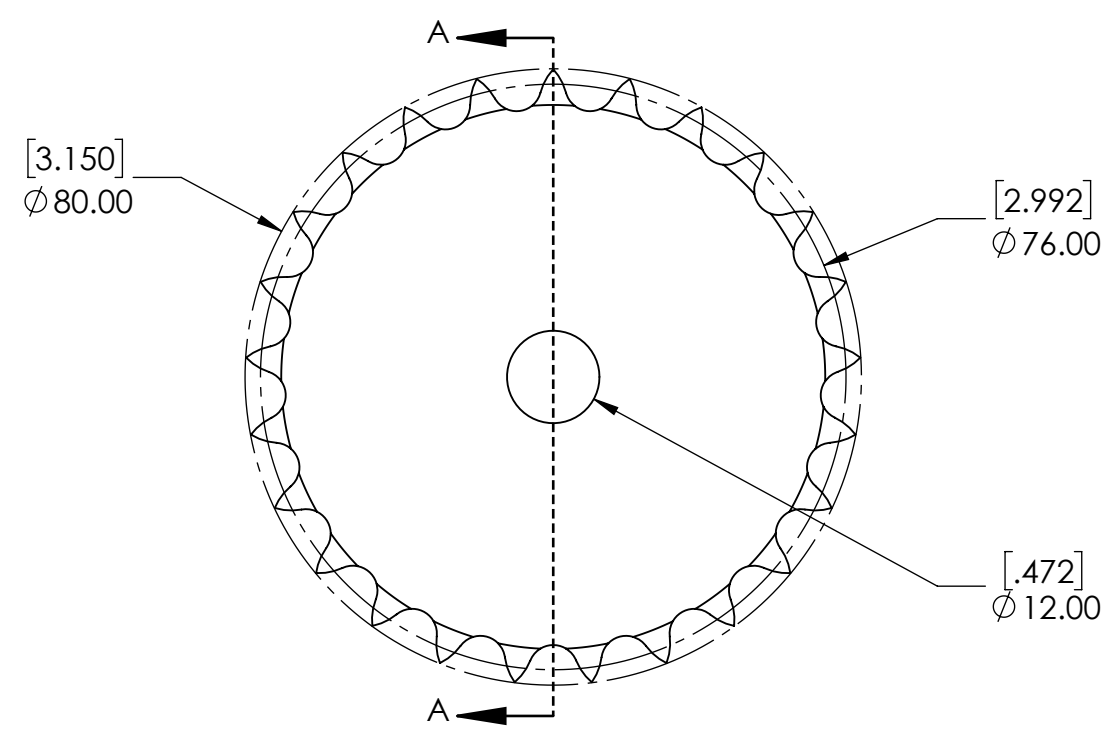

SECTION A-A

SPROCKETS SPECIFICATIONS		WEIGHT		DATE		BY		REVISION DESCRIPTION		REV	
UNITS	mm (INCH)	2.40 LBS									
CHAIN SIZE	06B	STEEL									
PITCH	9.525 mm	BLACK OXIDE		DRAWN		SEC		07/30/2025			
INNER WIDTH	5.72 mm			CHECKED		EG		07/30/2025			
ROLLER DIA.	6.35 mm			APPROVED							
TOOTH WIDTH	5.20 mm										
NUMBER OF TEETH	25										
HUB STYLE	B			DWG. NO.							
BORE TYPE	PLAIN BORE			PTI <small>INDUSTRIAL MOTION GROUP</small>		PROPRIETARY AND CONFIDENTIAL <small>THE INFORMATION CONTAINED IN THIS DRAWING IS THE SOLE PROPERTY OF SOLVE IMG. ANY REPRODUCTION IN PART OR AS A WHOLE WITHOUT THE WRITTEN PERMISSION OF SOLVE IMG IS PROHIBITED.</small>					
BUSHING NUMBER	N/A										
				ITEM DESCRIPTION:				06B-3-25B		SCALE	
										1:1	
										REV	
										-	

9 8 7 6 5 4 3 2 1