

9 8 7 6 5 4 3 2 1

G
F
E
D
C
B
A

G
F
E
D
C
B
A

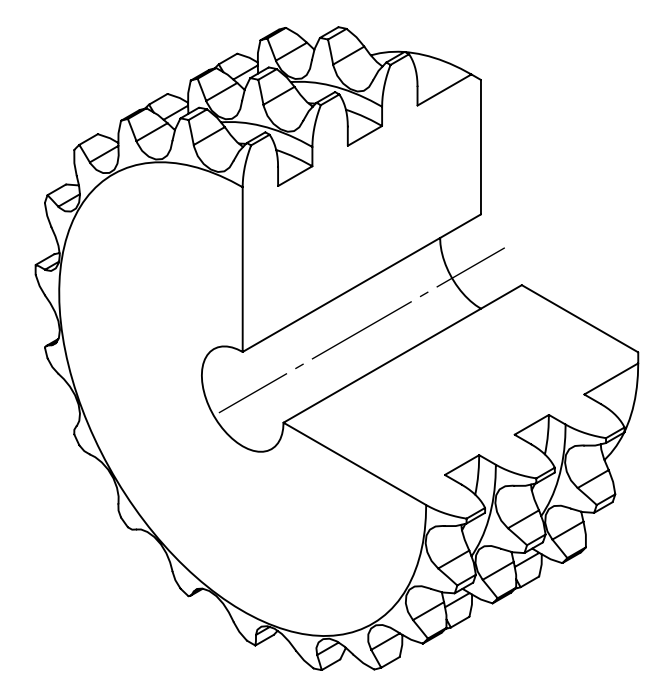
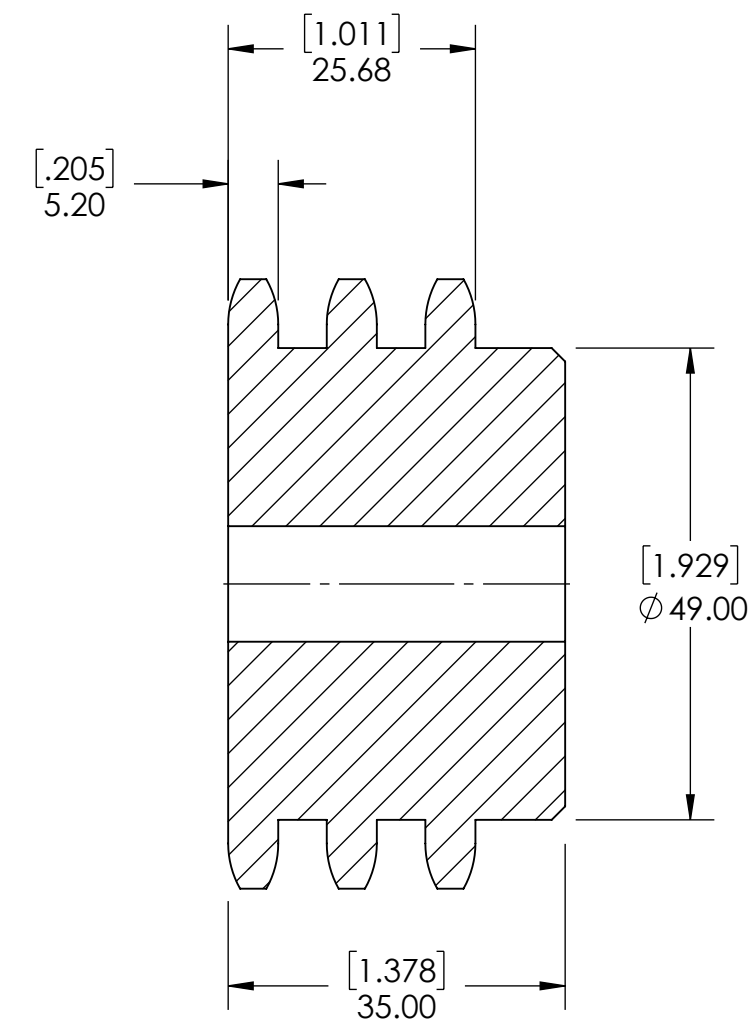
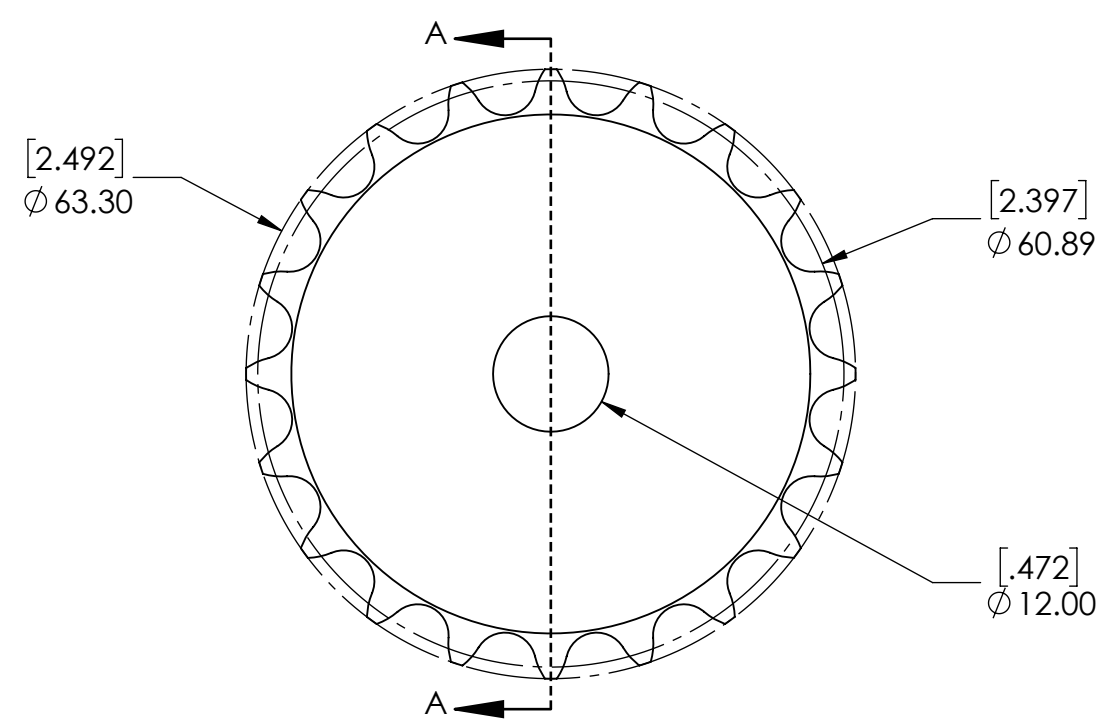

SECTION A-A

SPROCKETS SPECIFICATIONS		WEIGHT		1.27 LBS	
UNITS	mm (INCH)	MATERIAL	STEEL		
CHAIN SIZE	06B	COATING	BLACK OXIDE		
PITCH	9.525 mm	DRAWN	SEC	07/30/2025	
INNER WIDTH	5.72 mm	CHECKED	EG	07/30/2025	
ROLLER DIA.	6.35 mm	APPROVED			
TOOTH WIDTH	5.20 mm	DATE	BY	REVISION DESCRIPTION	
NUMBER OF TEETH	20	ITEM DESCRIPTION:		06B-3-20B	
HUB STYLE	B	DWG. NO.		SCALE	
BORE TYPE	PLAIN BORE			1:1	
BUSHING NUMBER	N/A	PROPRIETARY AND CONFIDENTIAL <small>THE INFORMATION CONTAINED IN THIS DRAWING IS THE SOLE PROPERTY OF SOLVE IMG. ANY REPRODUCTION IN PART OR AS A WHOLE WITHOUT THE WRITTEN PERMISSION OF SOLVE IMG IS PROHIBITED.</small>		REV	
				-	

9 8 7 6 5 4 3 2 1