

9 8 7 6 5 4 3 2 1

G  
F  
E  
D  
C  
B  
A

G  
F  
E  
D  
C  
B  
A

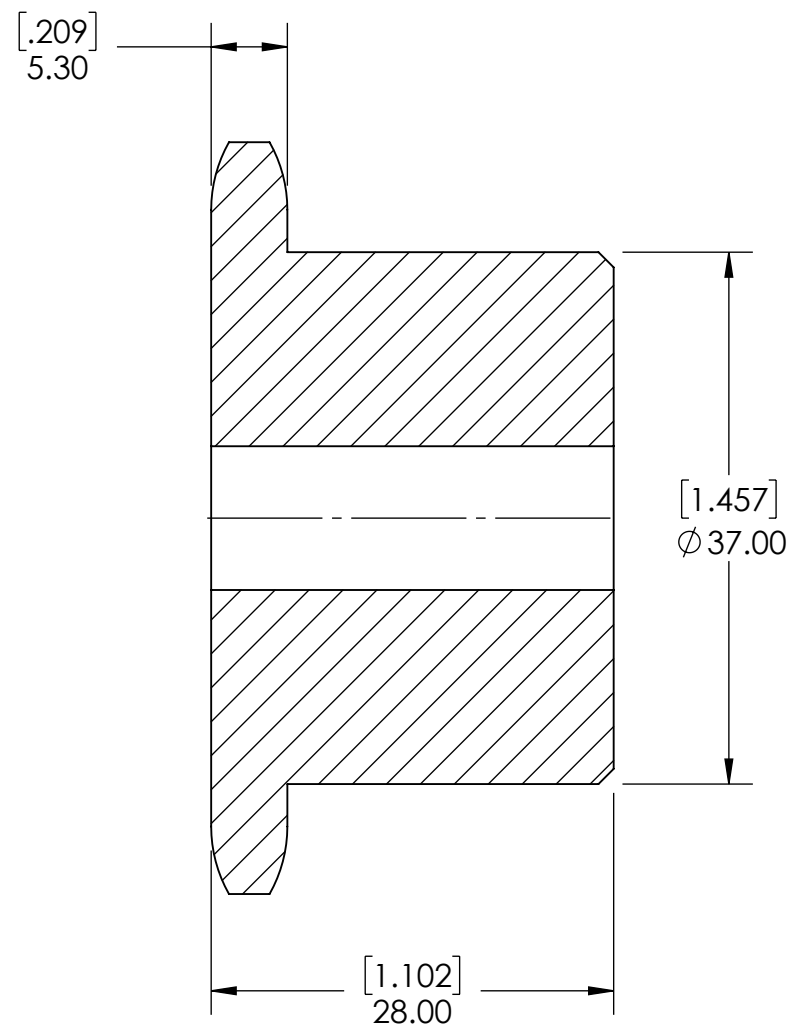
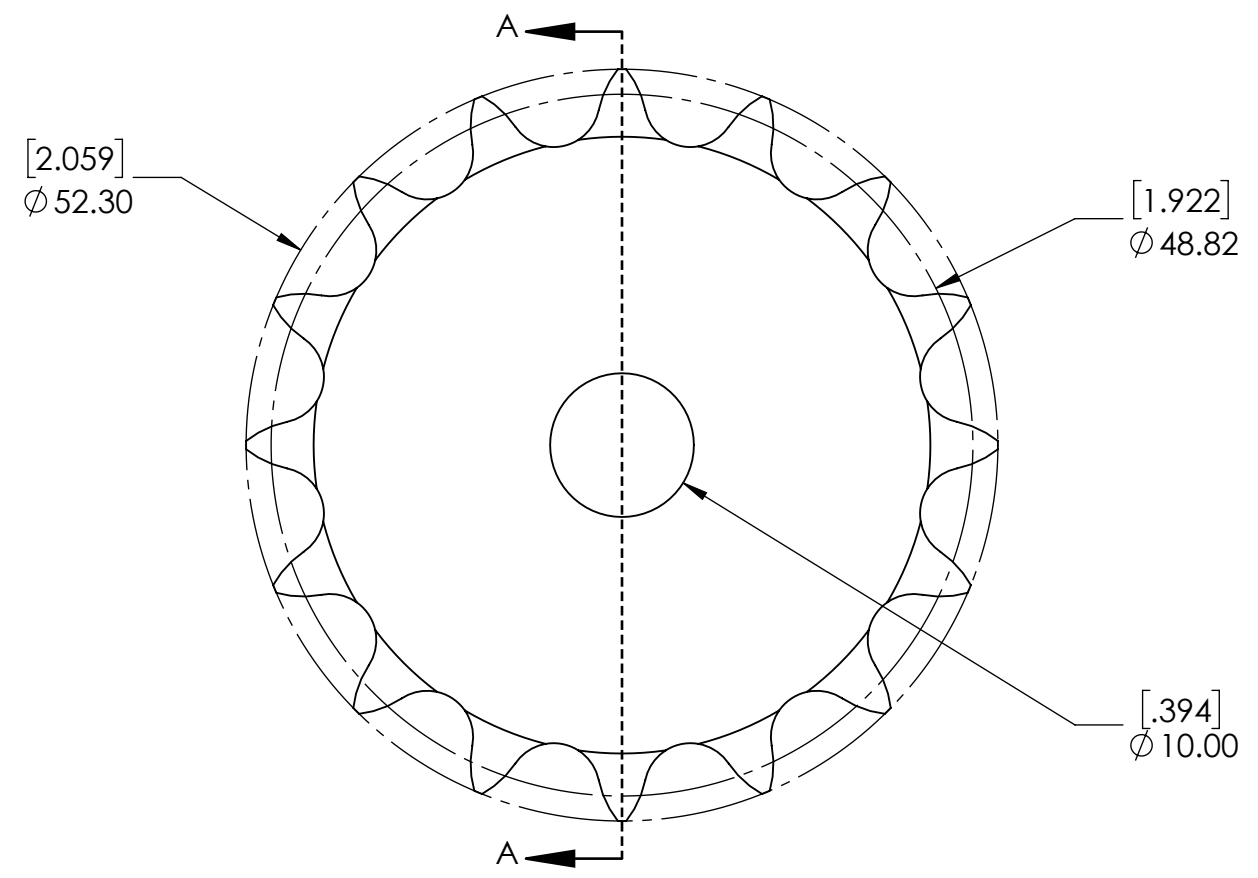

SECTION A-A

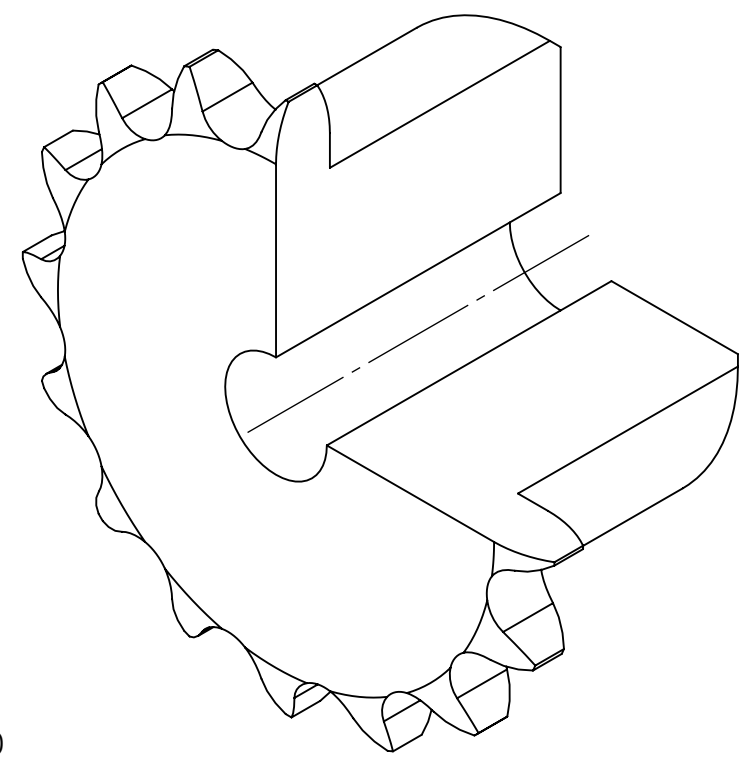

SPROCKETS SPECIFICATIONS		WEIGHT		0.53 LBS	
UNITS	mm (INCH)	MATERIAL	STEEL		
CHAIN SIZE	06B	COATING	BLACK OXIDE		
PITCH	9.525 mm	DRAWN	SEC	07/16/2025	
INNER WIDTH	5.72 mm	CHECKED	EG	07/16/2025	
ROLLER DIA.	6.35 mm	APPROVED			
TOOTH WIDTH	5.30 mm	DATE	BY	REVISION DESCRIPTION	
NUMBER OF TEETH	16	ITEM DESCRIPTION:		06B-16B	
HUB STYLE	B	DWG. NO.		SCALE	
BORE TYPE	PLAIN BORE			1:1	
BUSHING NUMBER	N/A	<b>PROPRIETARY AND CONFIDENTIAL</b> <small>THE INFORMATION CONTAINED IN THIS DRAWING IS THE SOLE PROPERTY OF SOLVE IMG. ANY REPRODUCTION IN PART OR AS A WHOLE WITHOUT THE WRITTEN PERMISSION OF SOLVE IMG IS PROHIBITED.</small>		REV	
				-	

9 8 7 6 5 4 3 2 1