

9 8 7 6 5 4 3 2 1

G
F
E
D
C
B
A

G
F
E
D
C
B
A

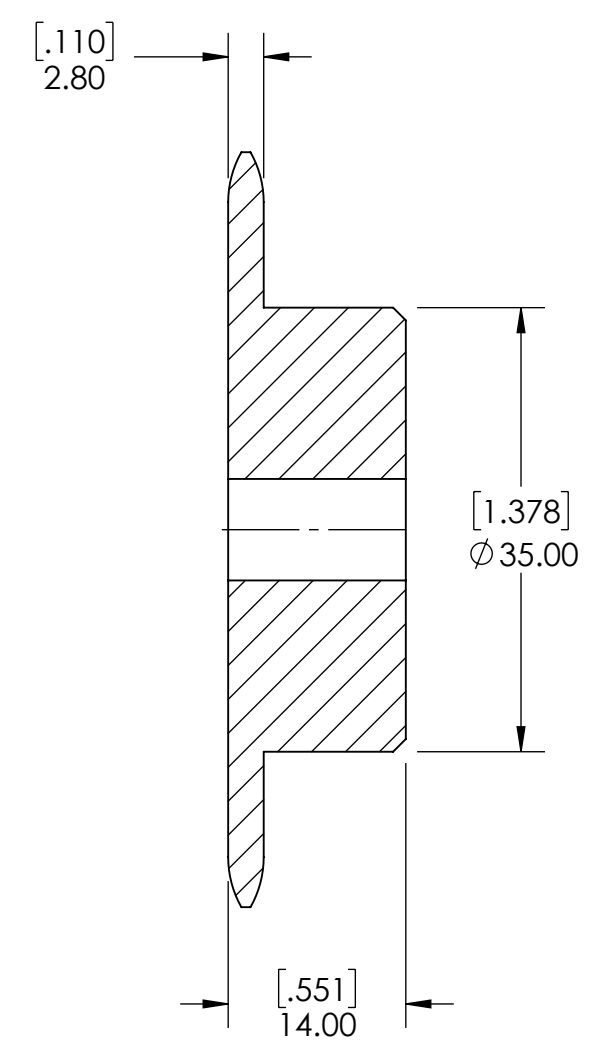
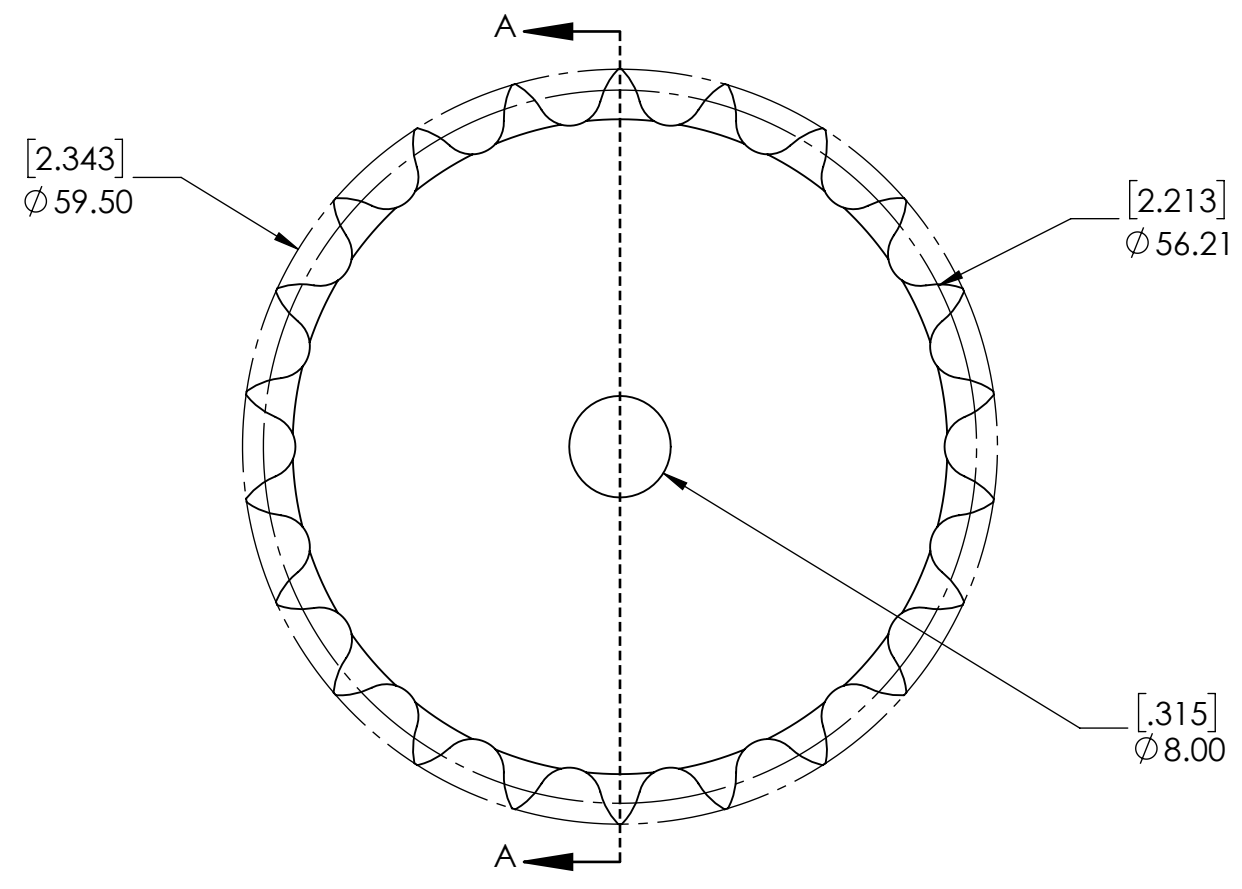

SECTION A-A

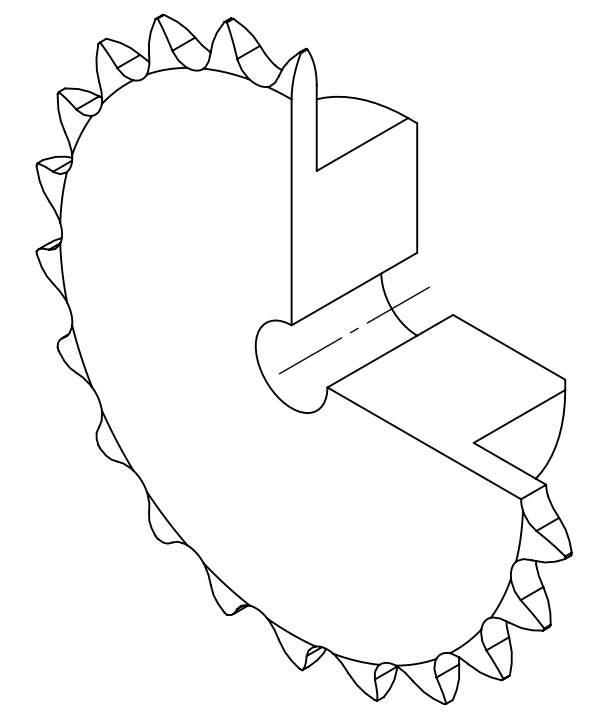

SPROCKETS SPECIFICATIONS		WEIGHT		DATE		BY		REVISION DESCRIPTION		REV
UNITS	mm (INCH)	0.28 LBS								
CHAIN SIZE	05B	MATERIAL	STEEL							
PITCH	8.00 mm	COATING	BLACK OXIDE							
INNER WIDTH	3.00 mm	DRAWN	SEC	07/16/2025						
ROLLER DIA.	5.00 mm	CHECKED	PT	08/11/2025						
TOOTH WIDTH	2.80 mm	APPROVED								
NUMBER OF TEETH	22					ITEM DESCRIPTION:		05B-22B		SCALE
HUB STYLE	B									DATE
BORE TYPE	PLAIN BORE	DWG. NO.		PROPRIETARY AND CONFIDENTIAL						REV
BUSHING NUMBER	N/A			<small>THE INFORMATION CONTAINED IN THIS DRAWING IS THE SOLE PROPERTY OF SOLVE IMG. ANY REPRODUCTION IN PART OR AS A WHOLE WITHOUT THE WRITTEN PERMISSION OF SOLVE IMG IS PROHIBITED.</small>						-

9 8 7 6 5 4 3 2 1